

# Controlling the evacuation of the inhabitants of the Popocatepetl area using cars



# *CENTIA, Lines of research*

- Graphics and Image Processing
- Mathematics and Algorithms
- Digital Libraries
- Educational Software
- Case Based Reasoning
- Speech Recognition
- Neural Networks
- Robotics
- Data Management and Distributed Systems
- Digital Cartography

[www.udlap.mx/~centia](http://www.udlap.mx/~centia)  
[www.udlap.mx/~gisudla](http://www.udlap.mx/~gisudla)



# Popocatepetl



# *Popocatépetl Volcano Location*

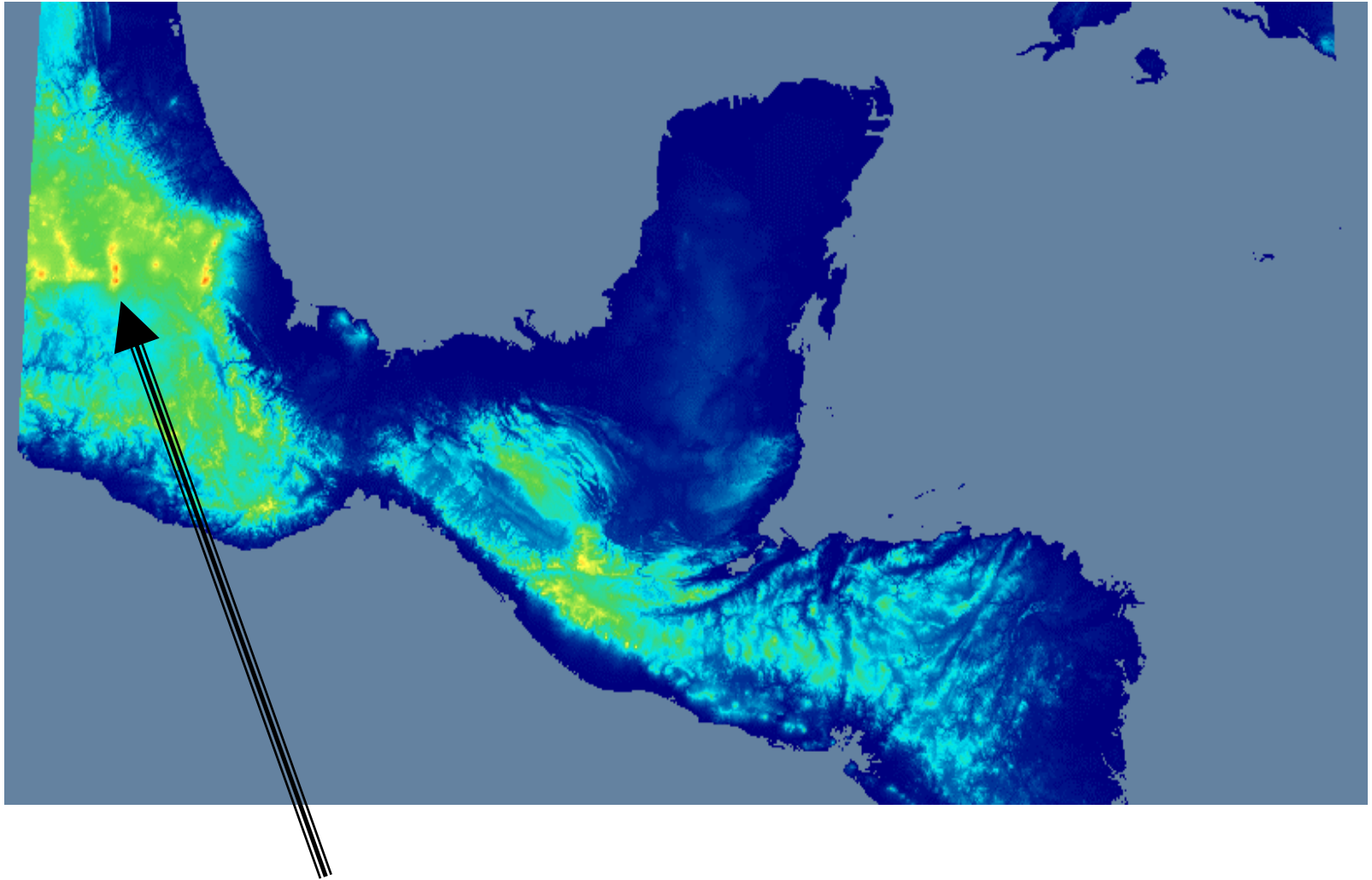

**Popocatépetl Volcano**



**Fraunhofer** Institut  
Rechnerarchitektur  
und Softwaretechnik

# *Popocatépetl Volcano*

- **stratum volcano**
- **surface 500 km<sup>2</sup>**
- **diameter of the crater 900m**
- **5452 m height**
- **depth of the crater 150m**
- **states: Puebla, México and Morelos.**



- **Since 1994 repeated active in December 2000 last evacuation**
- **About 60.000 people live in the most dangerous region**
- **People have to be evacuated with busses lorries and private cars on the given street network**



# Emergency Map

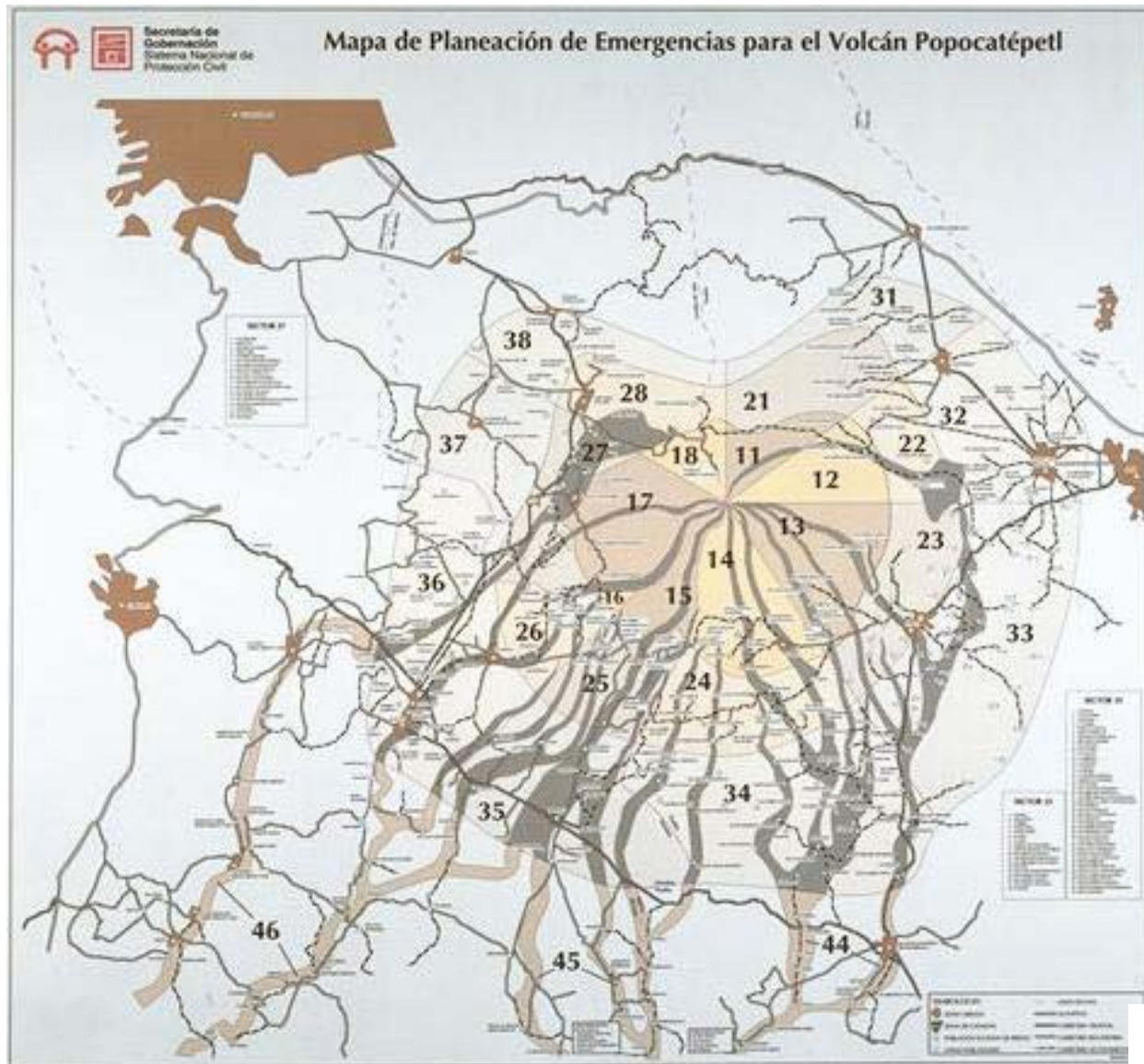



# *Digital Map Popocatépetl Zone*

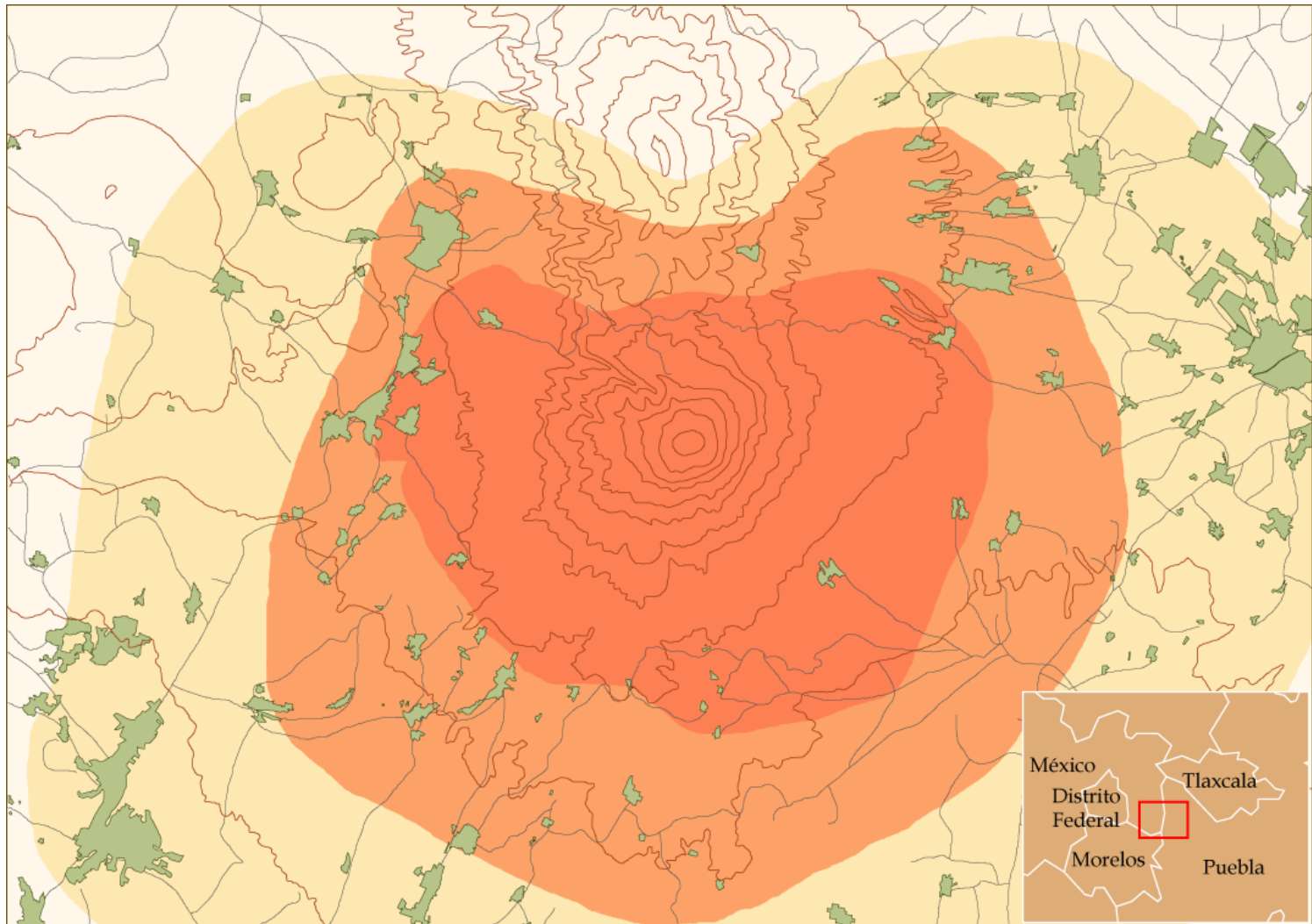

**ArcView Map**



**Fraunhofer** Institut  
Rechnerarchitektur  
und Softwaretechnik

# *Aim of the project*

- Investigation of the given evacuation plans whether bottlenecks (traffic jams) could occur.
- Methods of traffic simulation together with optimization methods will be used to ensure that the inhabitants of the dangerous region will be evacuated in shortest possible time.
- It is necessary that these methods provide quantitative values of the evacuation time.





# OpenGIS: Geometries represented

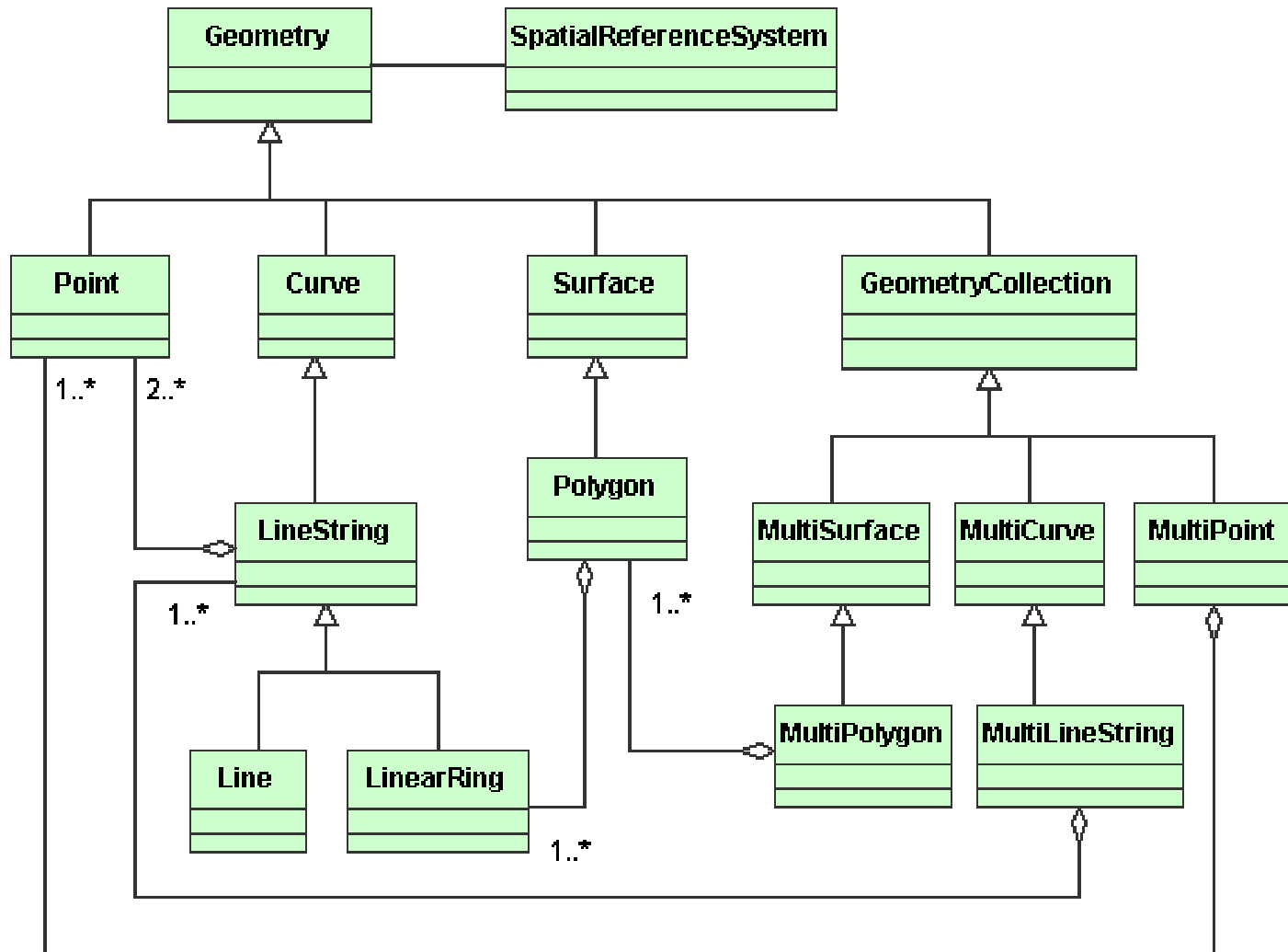

# Road description

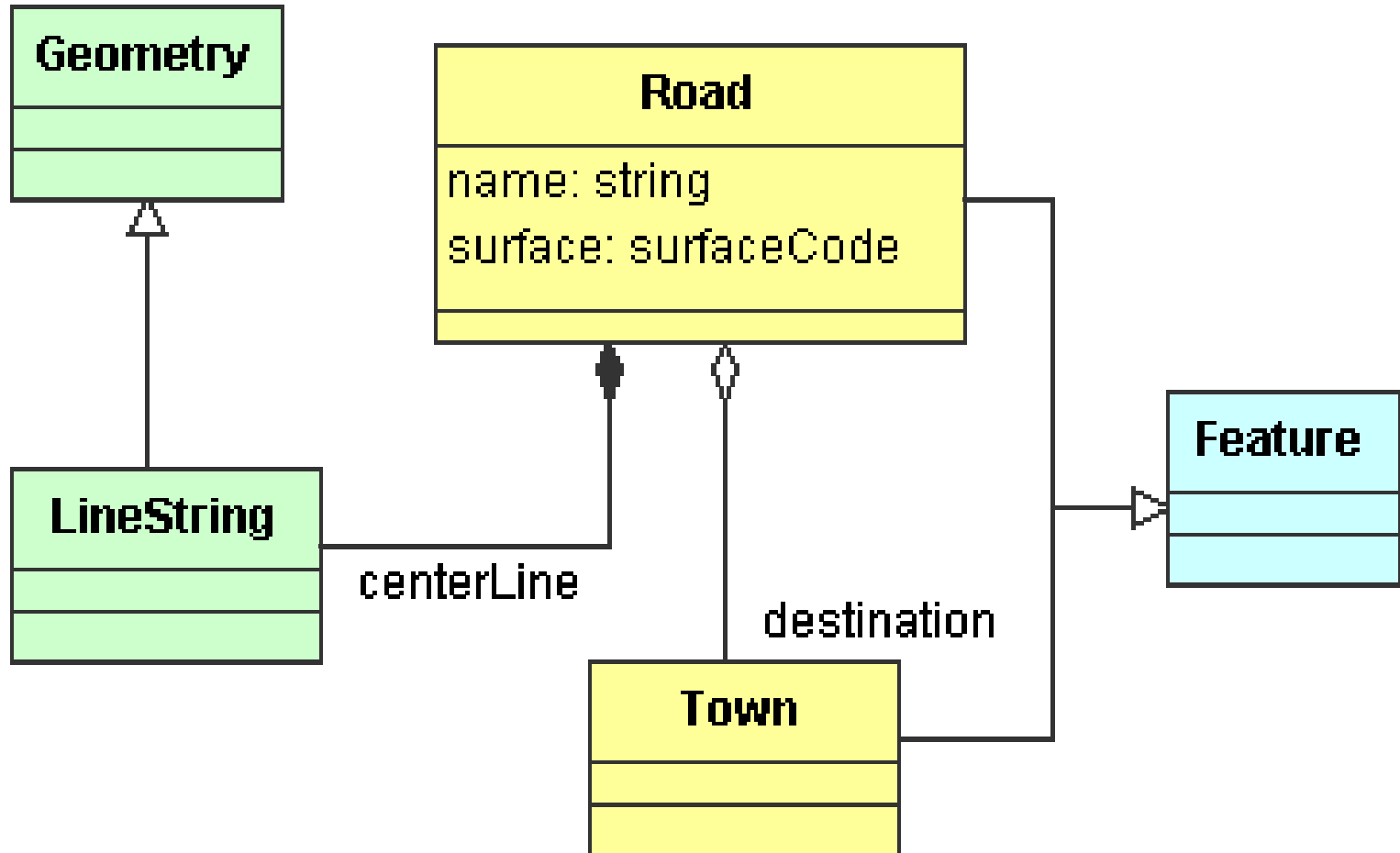

# Data Model

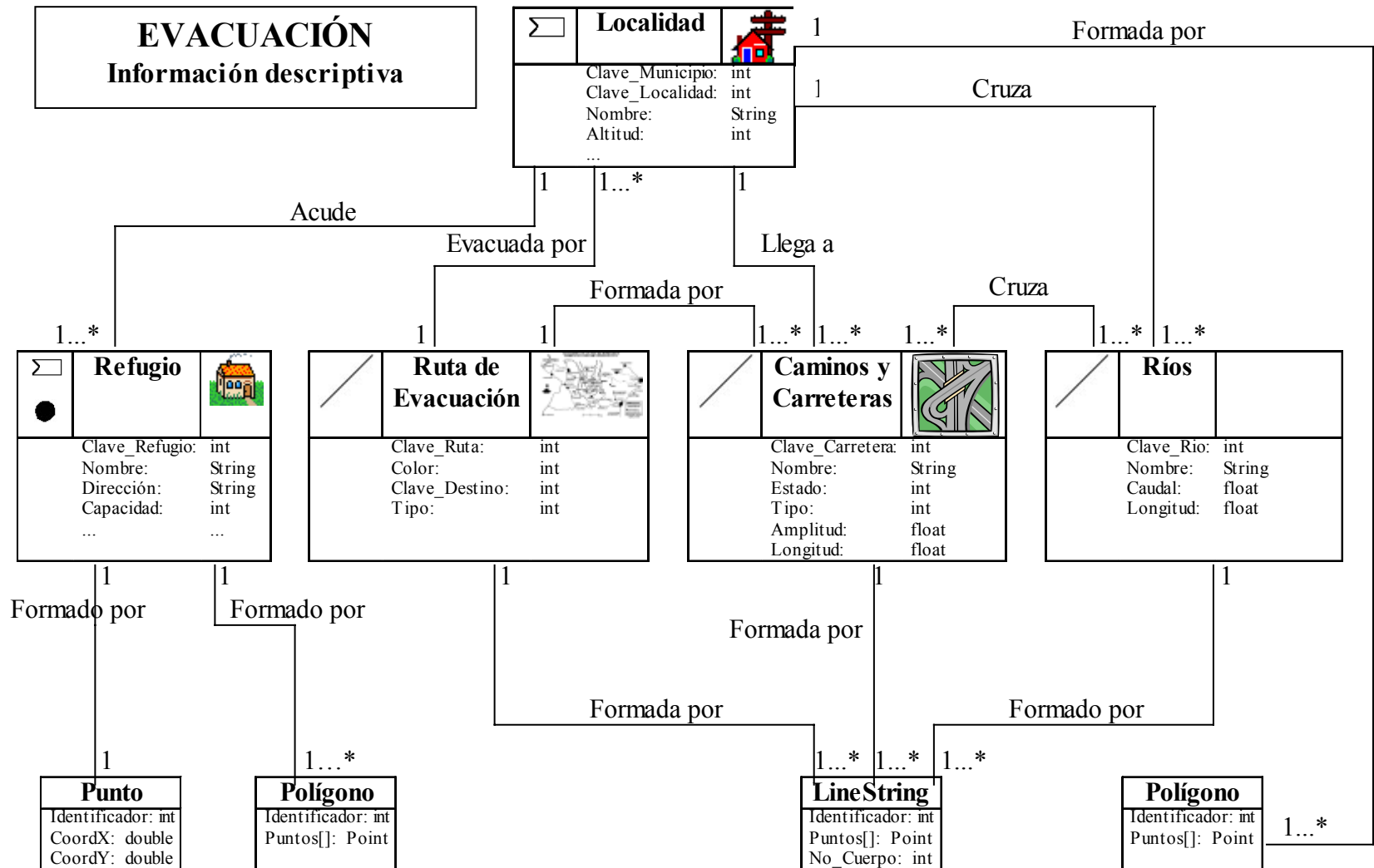

# *Requirements of this approach*

- Complete description of the traffic network, including the
  - turning relations,
  - speed limits ,
  - kind of the pavement,
  - one-way streets,
  - number of lanes.
- details of the given evacuation plans like
  - available cars,
  - shelter rooms,
  - number of inhabitants,
  - evacuation routes.



# General Architecture

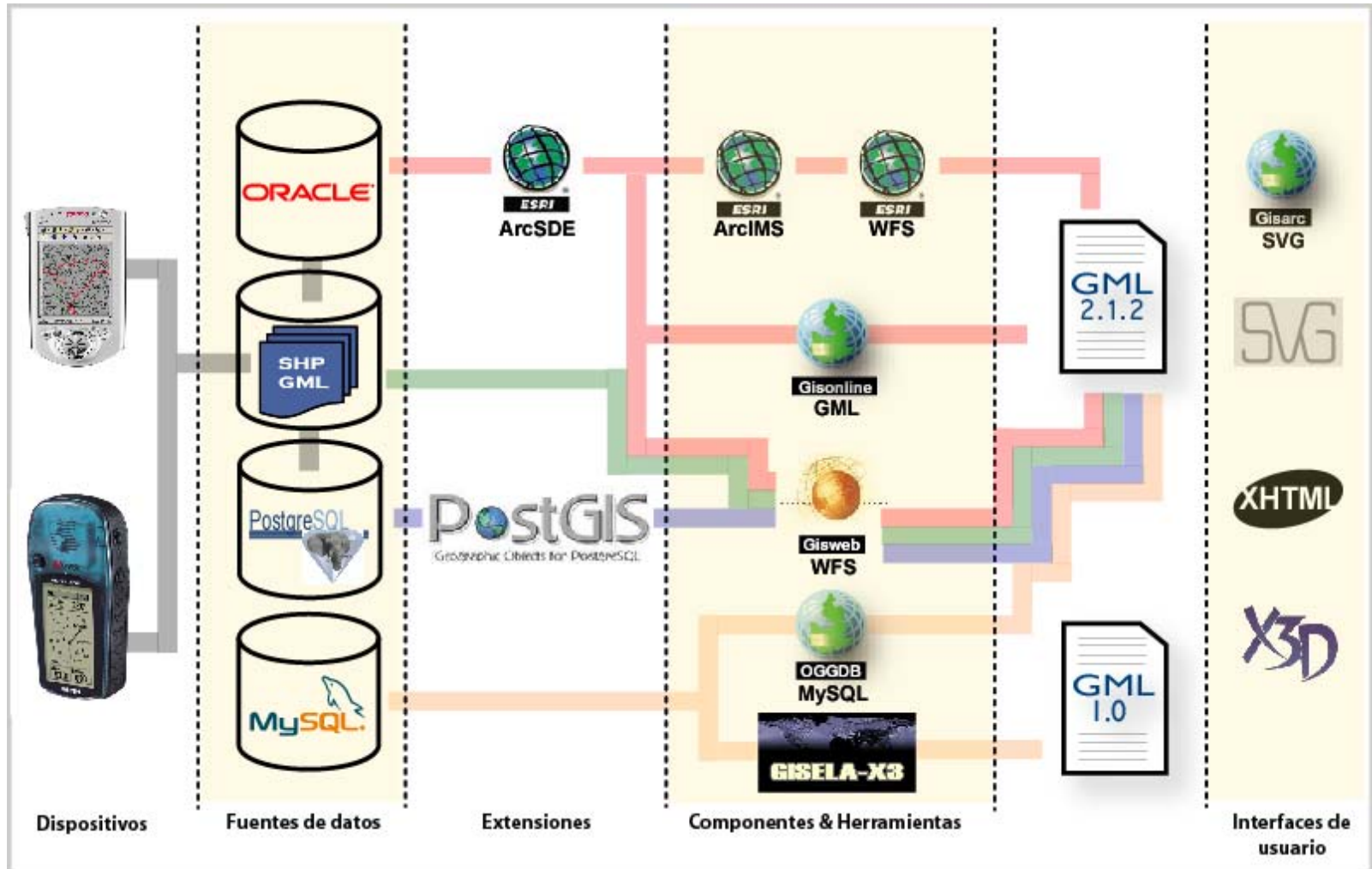

# *What is GML ?*

GML or Geography Markup Language is an XML based encoding standard for geographic information

[www.opengis.net/gml/02-069/GML2-12.html](http://www.opengis.net/gml/02-069/GML2-12.html)



**GML example**



Fraunhofer  
Institut  
Rechnerarchitektur  
und Softwaretechnik



## ***Important questions to solve within the project***

- How long it will take to evacuate all inhabitants from the dangerous region maintaining of the given evacuation plans (following the given roads to shelter rooms)? On which roads appear traffic congestions?
- Is it be possible to reduce the probability of traffic congestions by a time shifted departure of the evacuation fleet from the different villages? What time reduction provides this measure?
- Could we reduce the evacuation time if instead of the given evacuation routes alternative routes will be chosen? Does it make sense if the fixed assignment of the people to the shelter rooms will be changed?



# *Data Management for Simulation*

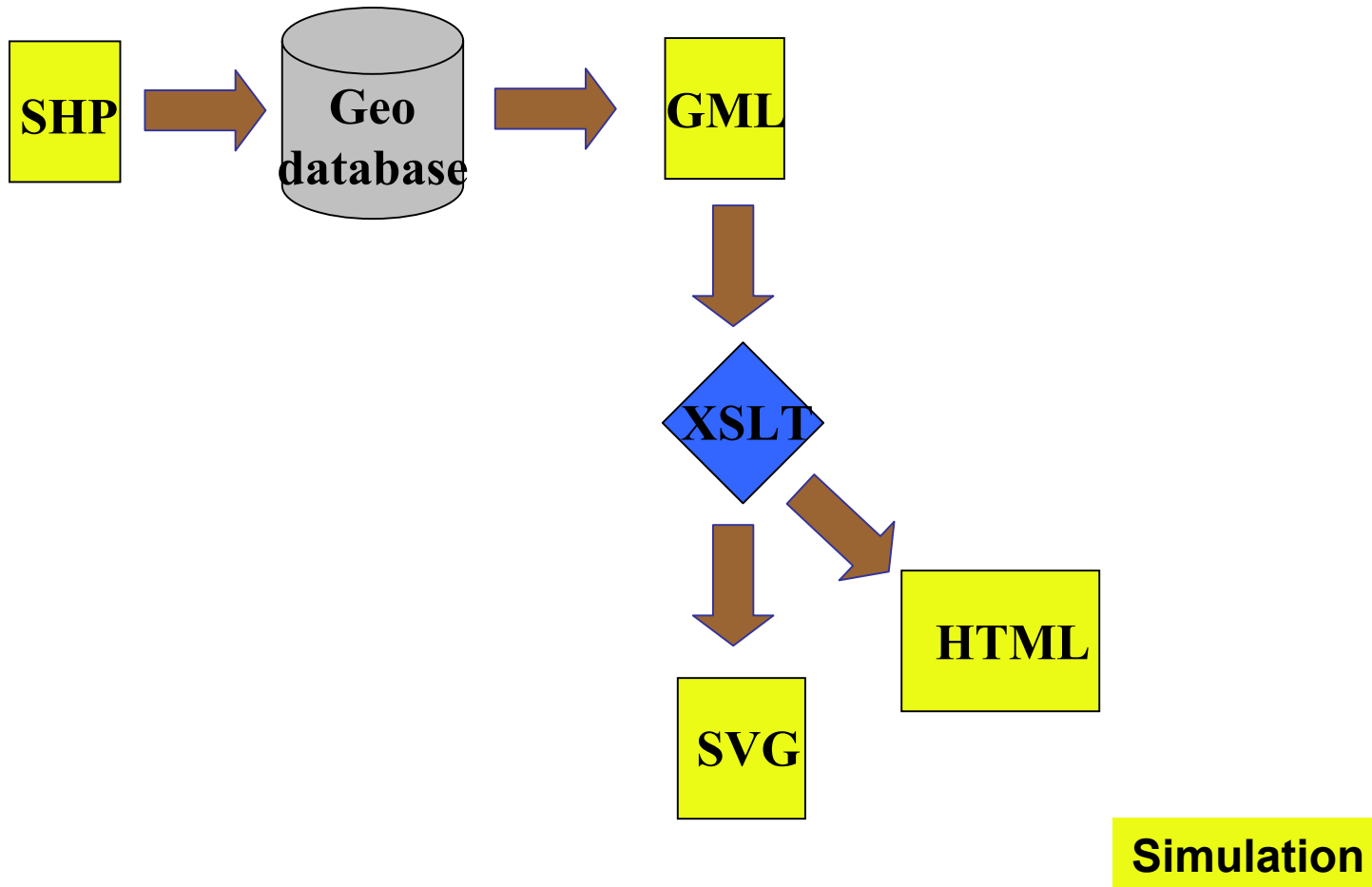

# *Conclusions and Perspective Work*

## **Conclusions**

- Data Set
- Data Model
- Architecture of Collaboration
- Visualization

## **Perspectives**

- The necessary traffic simulation methods are developed and mostly implemented.
- We expect to present final results by the end of this year.
- 3D Visualization



# Evacuation Simulation in 3D

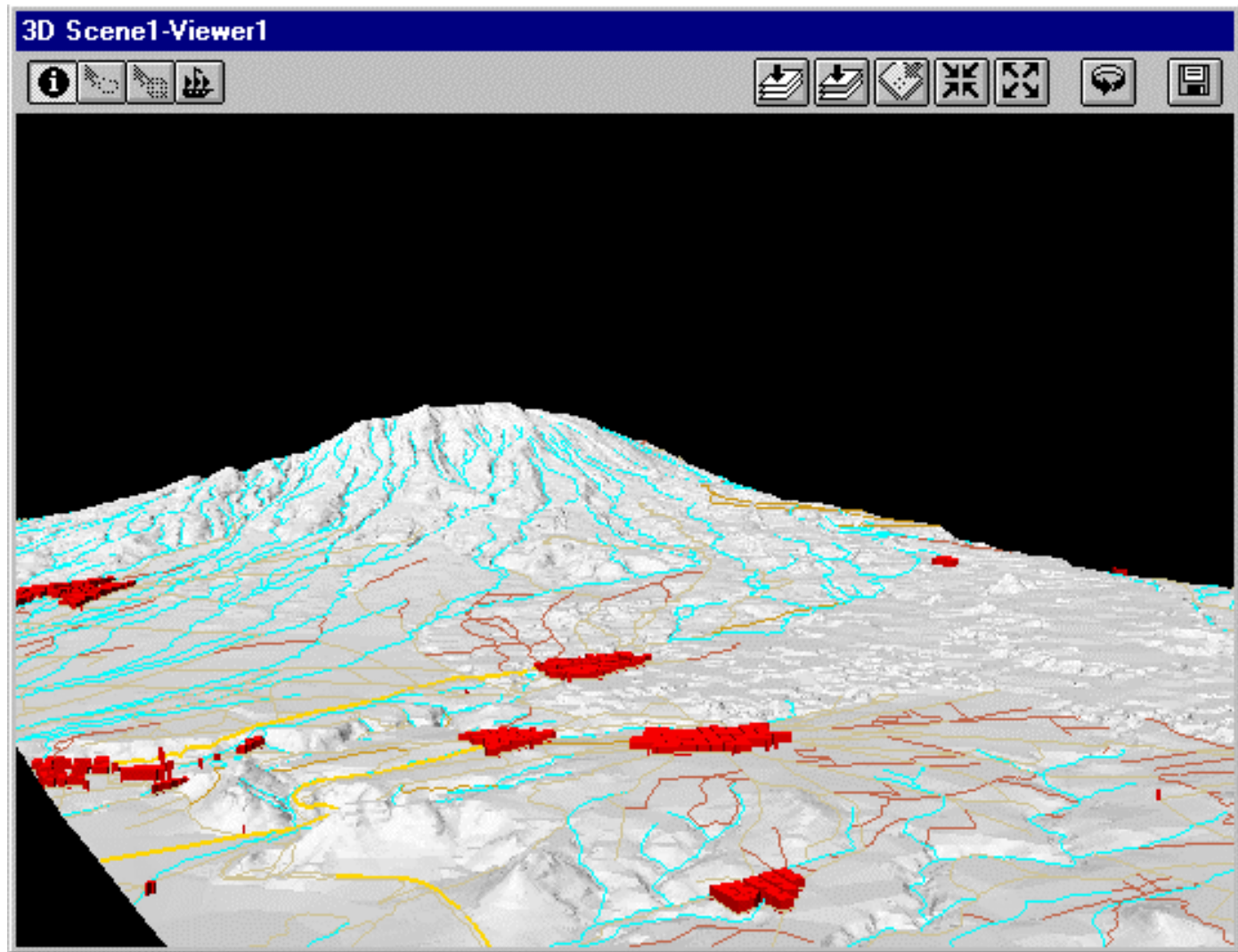

**david.sol@udlap.mx**

**matthias.schmidt@fraunhofer.first.de**



**Fraunhofer** Institut  
Rechnerarchitektur  
und Softwaretechnik